

CLEAN ROOM GRID SYSTEM

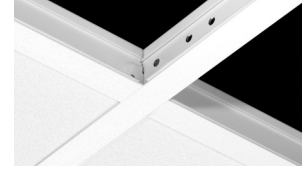

Exposed 24 mm grid system (nominal). A complete system solution: Aluminium construction for maximum corrosion resistance and non-magnetic environments. Co-extruded with a unique factory applied gasket for a better seal between tile and grid. System suitable for use in applications up to Class 4 performance as per Class ISO standard 14644-1.

Main Runner Clean Room Grid System 24

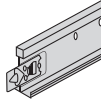
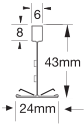

Item Nr.	Dimensions		Content / Carton		Weight / Carton kg	Cartons / Pallet
	length (mm)	height (mm)	pcs	lm		
EA 794044	3600	43	20	72,00	24,00	30

Cross Tees Clean Room Grid System 24 + Perimeter Trim

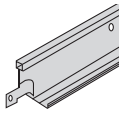
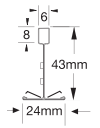

EA 793044	1200	43	60	72,00	26,00	20
EA 792044	600	43	60	36,00	12,00	40



EA 7801	3660	24	30	109,80	20,00	25
---------	------	----	----	--------	-------	----

Accessories

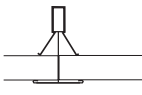

CHDC
Hold down clip suitable for non-magnetic areas

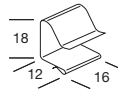

A 426
Board access clip

Section Drawings

Main Runner Clean Room Grid 24

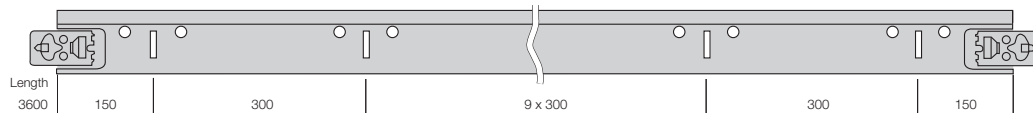

CrossTee Clean Room Grid 24

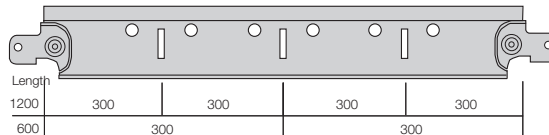

All measurements in millimetres. All sizes are nominal.
Please contact our **Armstrong Technical Sales** for further details.



CLEAN ROOM GRID SYSTEM

Key Attributes Physical Data

- Aluminium construction for maximum corrosion resistance and non-magnetic environments
- Unique co-extruded section aluminium based
- Unique, factory applied gasket for a better seal between tile and grid
- Staked on main runner splice for easy connections, integral hook cross tee end detail
- Hold down clips to ensure a good seal
- System suitable for use in applications up to Class 4 performance per ISO standard 14644-1

- **Material**
Co-Extruded Aluminium – Gasketed
- **Cross Tee/Main runner Interface**
Co-Extruded Aluminium Clean Room – Flush Fit
- **Product family**
Exposed grid system
- **End Detail**
Main Runner: Staked-on clip
Cross Tee: Integral hook

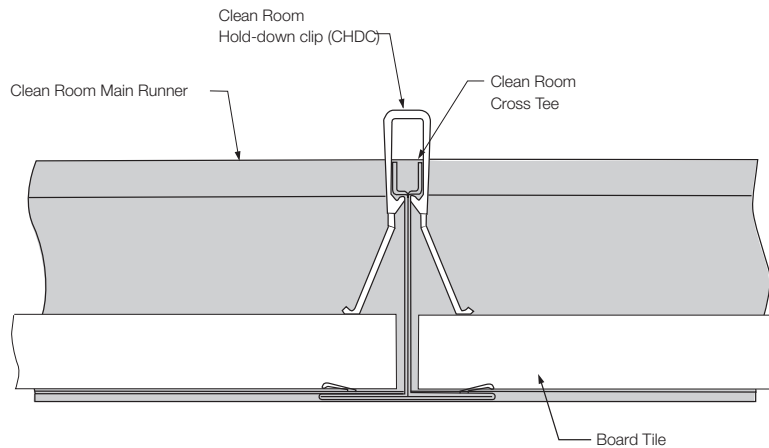

Grid Load Capacities

Clean Room Grid 24 mm

The table gives the maximum permitted hanger distance (mm) along the Clean Room Grid Main Runner (EA 794044) for the tile weights and Main Runner spacings noted.

Tile weight	Hanger spacing	
	Main Runner spacing 1200 mm 1200 mm Cross Tee EA 793044	Main Runner spacing 600 mm 600 mm Cross Tee EA 792044
2,5 kg/m ²	1850	2100
3,0 kg/m ²	1750	2100
3,5 kg/m ²	1700	2100
4,0 kg/m ²	1650	2050
5,0 kg/m ²	1550	1950
5,5 kg/m ²	1500	1900
6,0 kg/m ²	1450	1850
7,0 kg/m ²	1400	1800
8,5 kg/m ²	1300	1700
10,5 kg/m ²	1200	1600
13,0 kg/m ²	1050	1450

- 1) Values in the above table conform to Class 1 as defined in EN 13964:2004+A1:2006 table 6.
For other classes /deflection limits please contact your **local Armstrong Technical Sales**.
- 2) Values are determined from laboratory tests methods in accordance with EN 13964:2004+A1:2006 clause 5.
- 3) Values are applicable for 600 x 600 mm tiles assuming that the maximum deflection of the grid is L/500 but not greater than 4 mm (L = span).
- 4) **No other applied loads such as luminaires, air diffusers, smoke detectors, sprinklers, hanging signs etc. are permitted.**
- 5) No overlays such as mineral wool or fibre glass quilts, as may be required for enhanced acoustic, fire or thermal performance, are permitted unless their full weight is established and included, together with the weight of the tile, within the appropriate weight groups.
- 6) For grid loading data calculated to different criteria than Class 1 to EN13964:2004+A1:2006, please contact your local **Armstrong Technical Sales team**

All measurements in millimetres. All sizes are nominal.
Please contact our **Armstrong Technical Sales** for further details.

CENTRAL EUROPE NORTH (DK/EE/FIN/IS/LT/LV/N/PL/S)

Armstrong Building Products B.V.
Sp. z o.o. Oddział w Polsce
Ul. Domaniewska 37
02-672 Warszawa
Poland
Tel. : (+48) 22 337 86 10 / 86 11
Fax : (+48) 22 337 86 12
e-mail : service-ce@armstrong.com

Latvia : www.armstrong.lv
Lithuania : www.armstrong.lt
Norway : www.armstrong.no
Poland : www.armstrong.pl
Sweden : www.armstrong.se

