

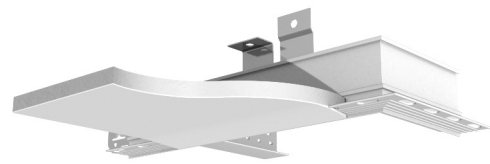

AXIOM TRANSITIONS





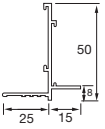
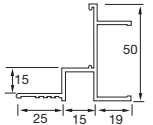
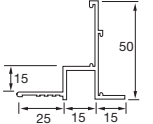
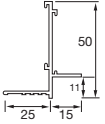
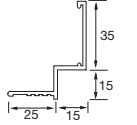

The 5 sections are designed to provide a flush transition between plaster margin and mineral, metal or wooden suspended ceilings.

Axiom Transitions

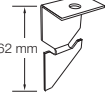
Item Nr.	Description	Dimensions		Content / Carton		Weight / Carton kg	Cartons / Pallet
		length (mm)	height (mm)	pcs	lm		
 T 3208 G ⁽¹⁾	Axiom Transitions for Tegular/MicroLook	3000	50	10	30,00	11,80	36
 T 3219 G ⁽¹⁾	Axiom Transitions channel	3000	50	10	30,00	17,10	36
 T 3215 G ⁽¹⁾	Axiom Transitions angle	3000	50	10	30,00	15,00	36
 T 3210 G ⁽¹⁾	Axiom Transitions for Vector tiles	3000	50	10	30,00	11,80	36
 T 3225 G ⁽¹⁾	Axiom Transitions plasterboard perimeter trim	3000	50	10	30,00	11,30	36

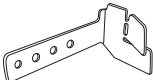
Accessories for Axiom Transitions

Item Nr.	Description	Dimensions height (mm)	Content / Carton pcs	Weight / Carton kg
 A 321 G	Axiom Transitions suspension clip – straight	79	100	2,10
 A 322 G	Axiom Transitions suspension clip – angled	62	100	2,10
 A 340 G	Axiom universal corner clip	-	100	2,10
 A 338 G	Axiom universal splice plate	-	100	2,10
 A 339 G	Axiom universal T bar connector clip	-	100	2,10
 A 344 G	Axiom universal hanging clip	-	100	2,10

(1) Also available in colour RAL 9010 (WR).

Note: As Axiom is an aluminium extrusion it should not be used in ceiling assemblies where structural fire protection is required. All measurements in millimetres. All sizes are nominal.

System Drawing

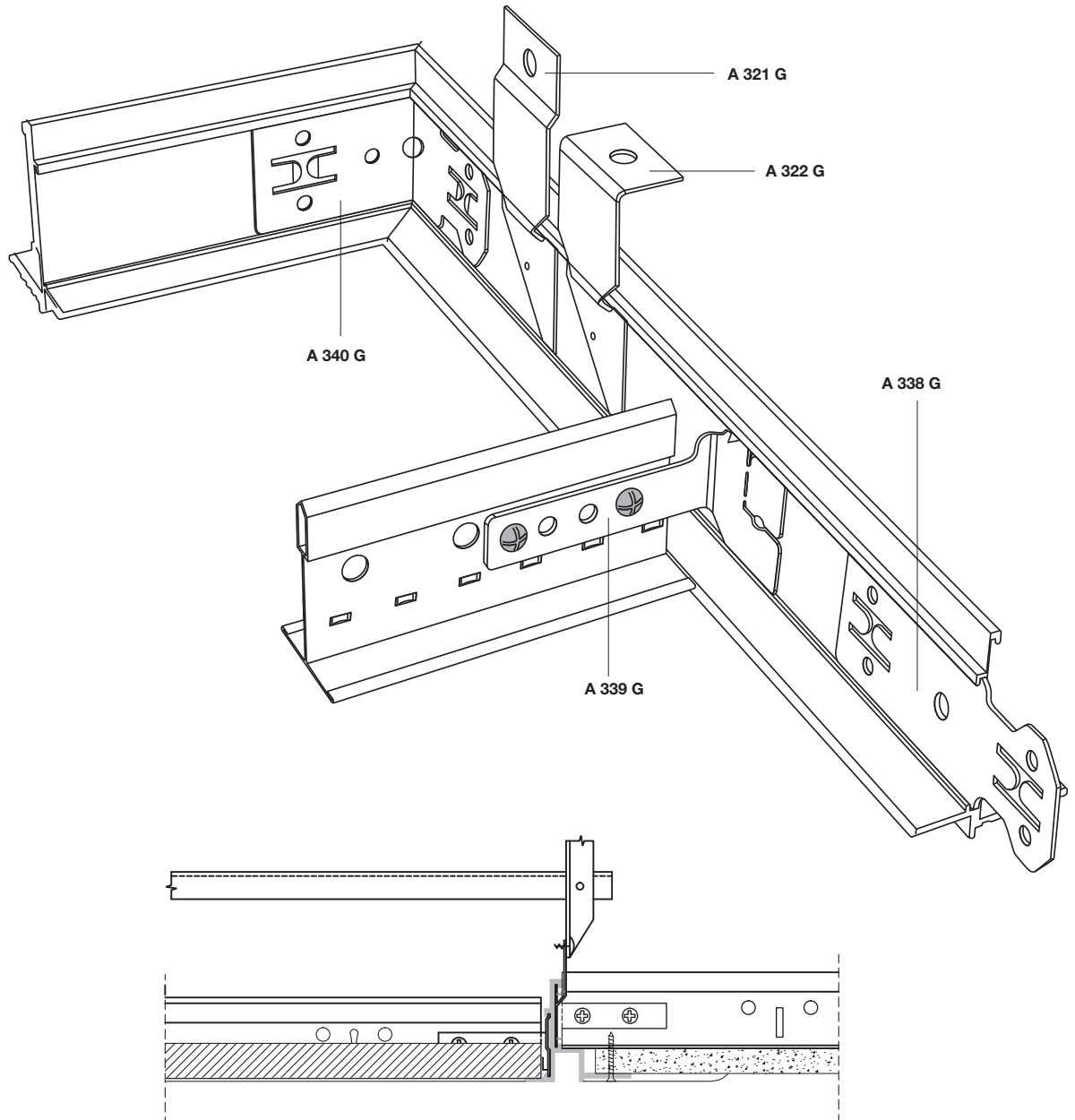
**CENTRAL EUROPE NORTH
(DK/EE/FIN/IS/LT/LV/N/PL/S)**

Armstrong Building Products B.V.
 Sp. z o.o. Oddział w Polsce
 Ul. Domaniewska 37
 02-672 Warszawa
 Poland
Tel. : (+48) 22 337 86 10 / 86 11
 Fax : (+48) 22 337 86 12
 e-mail : service-ce@armstrong.com

Latvia : www.armstrong.lv
Lithuania : www.armstrong.lt
Norway : www.armstrong.no
Poland : www.armstrong.pl
Sweden : www.armstrong.se